

# SWEDBE

Article: 8800, 8801, 8802, 8803, 8804, 8805, 8806, 8807, 8808, 8809, 8810, 8811, 8812, 8813, 8814, 8815, 8816, 8817, 8818, 8819, 8820, 8821, 8822, 8823, 8824, 8825, 8826, 8827, 8828, 8829, 8830, 8831, 8832, 8833, 8834, 8835, 8836, 8837, 8838, 8839, 8840

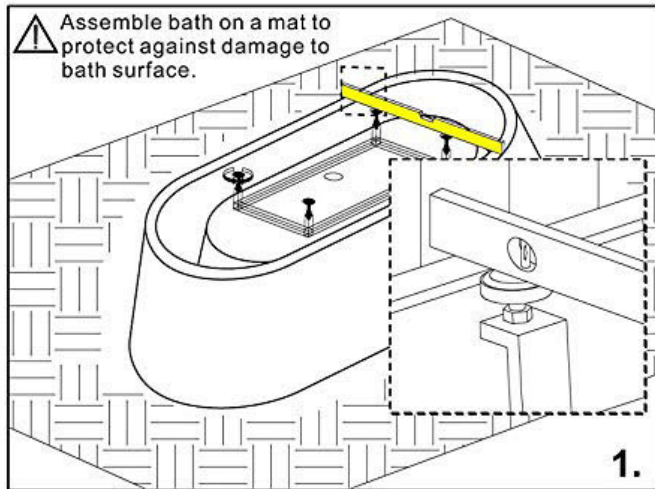

- Ensure legs are adjusted in line with the base of bath.

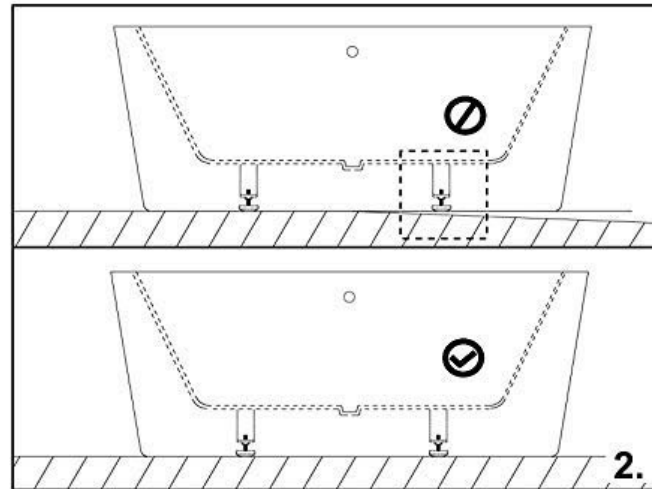

- Check that bath sits flat; if required adjust legs to compensate for floor level.

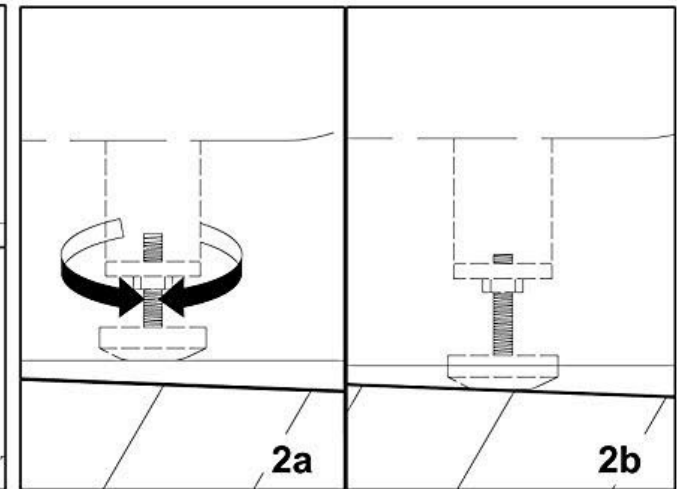

- ⚠ • Before step 3 set waste connection in position.

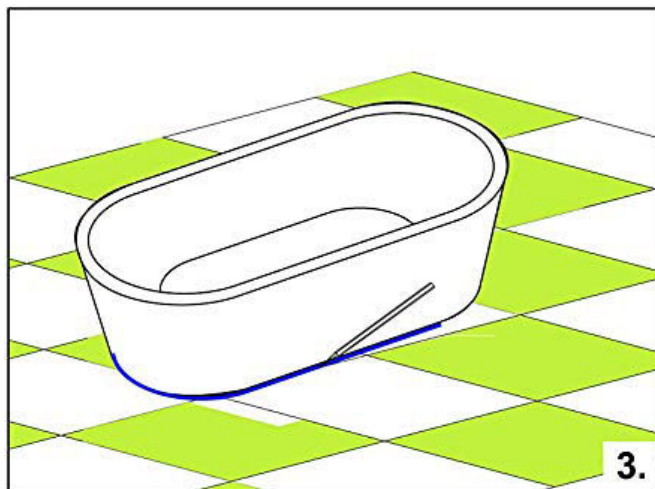

- With pencil trace outline of bath.

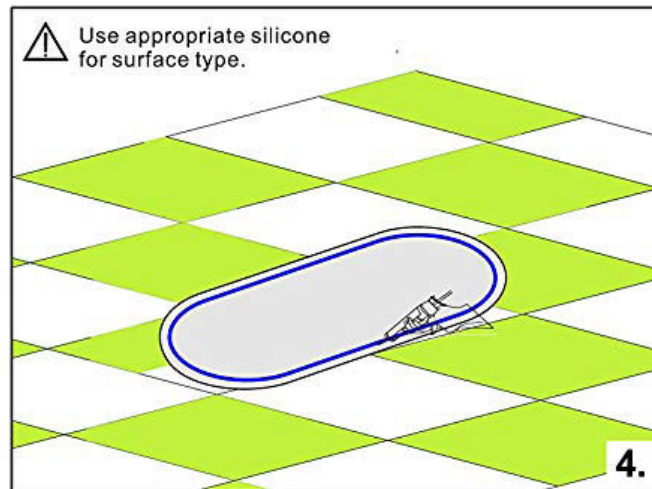

- Apply a thick bead of silicone within bath outline.

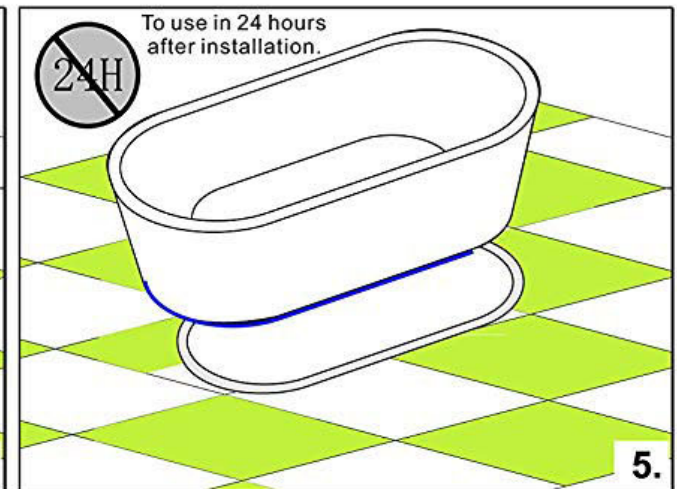

- Set bath in final position.

⚠ This installation guide does not include details of waste connection; final decision about installation of waste connection should be taken by a suitably qualified person.

# SWEDBE

Item Number: 8812

General dimension and draining hole location

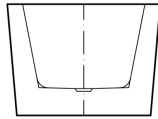
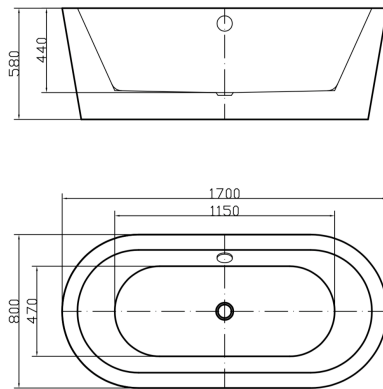

Measure the draining hole position according to the provided drawing.

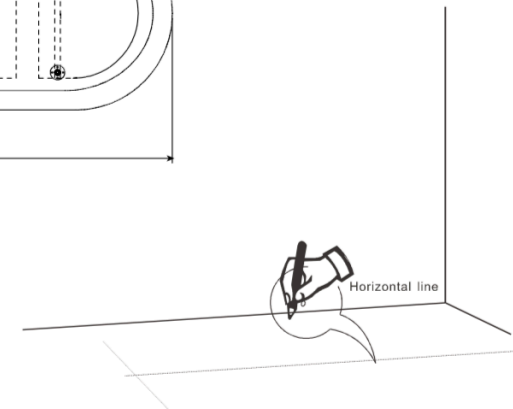
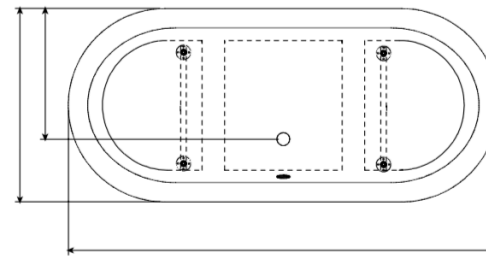

Please arrange the draining system according to your real situation and it's proposed that qualified person to finish the draining system arrangement.