

+

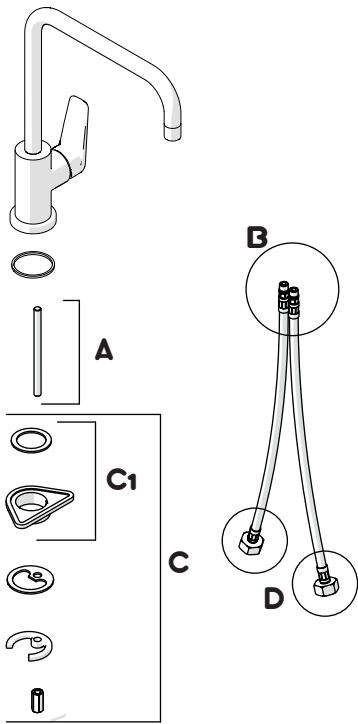

Not included / Non incluso / Non inclus / Nie zawarty / No incluido / Não incluido



1

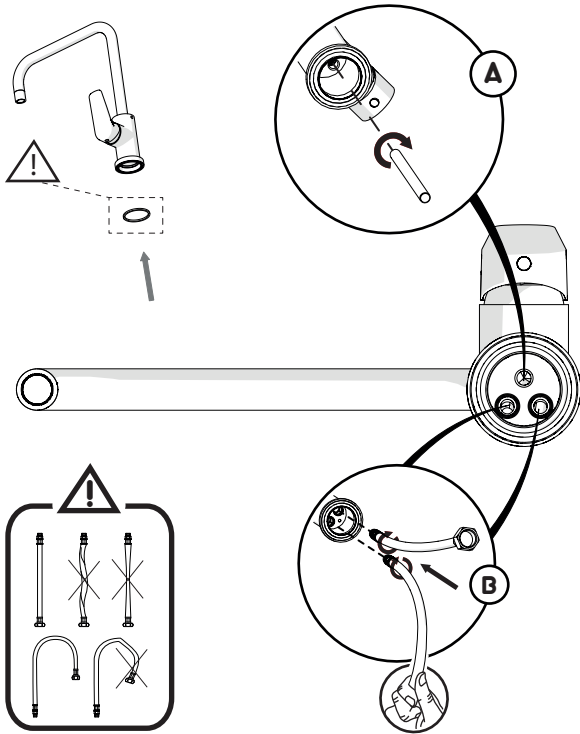

3

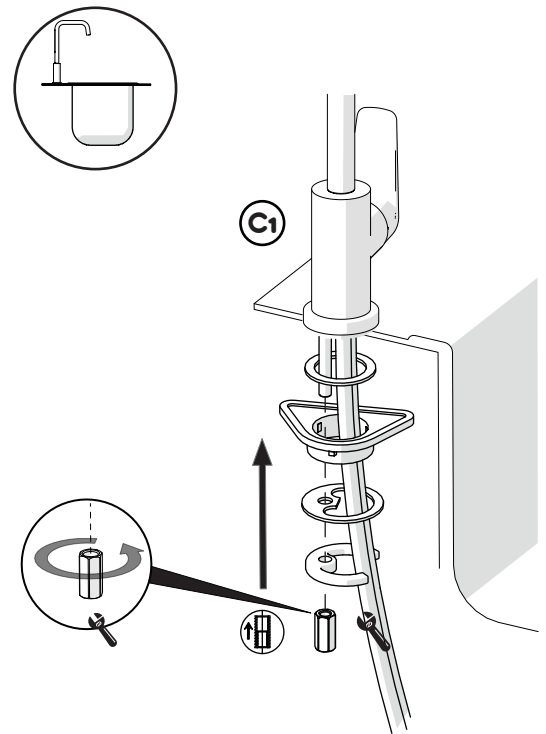

5

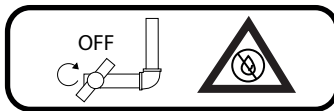
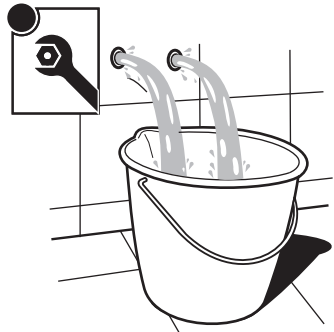
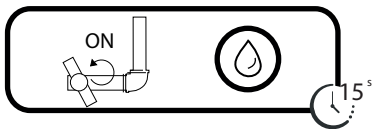

2

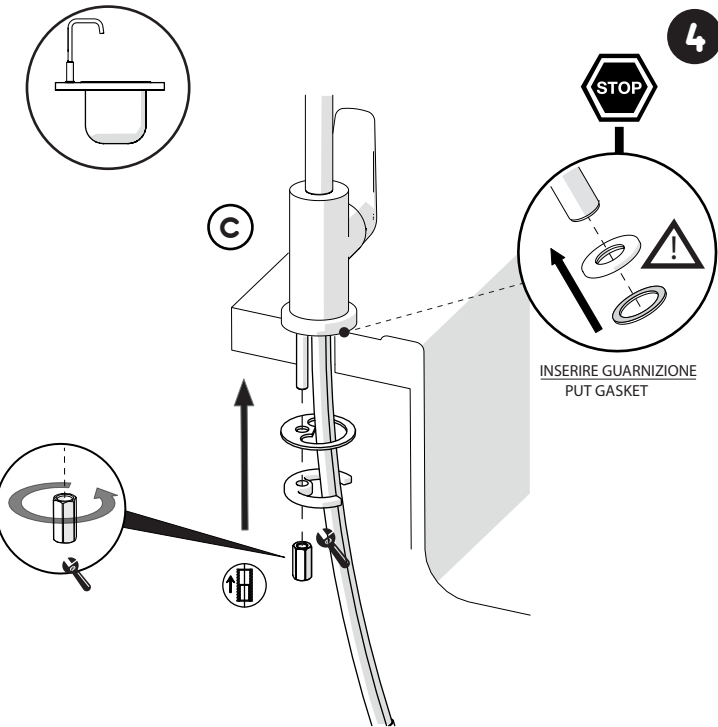

4

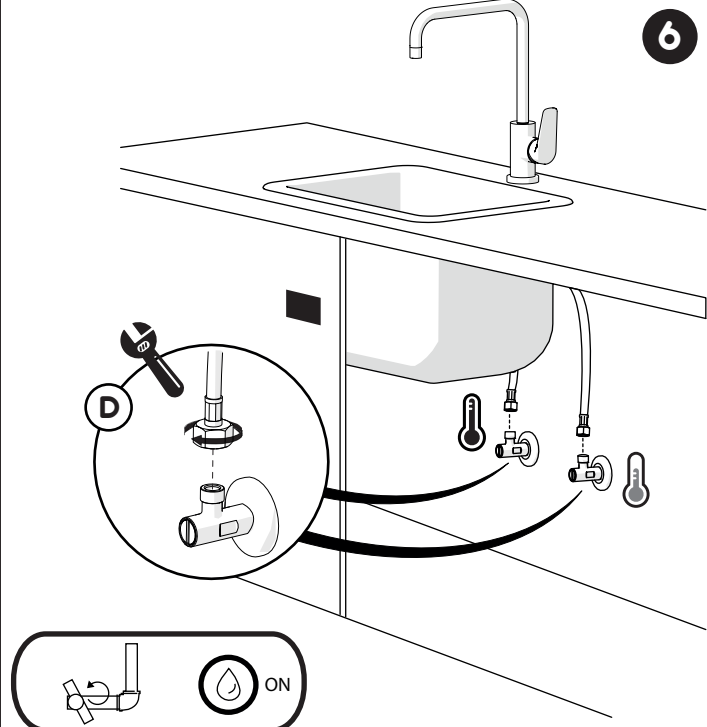

6

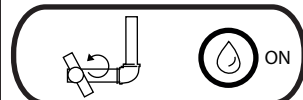

-50%

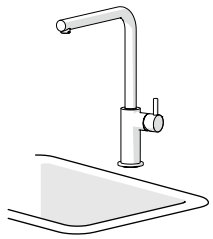

7

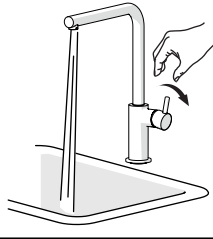

ON 50%

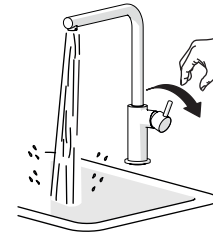

ON 100%



Per limitare la temperatura estrarre il limitatore e riposizionarlo nella posizione che si desidera

Extract the limiter and put it in correct position to limit temperature

9

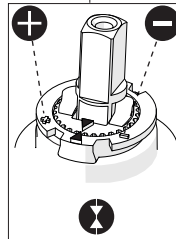
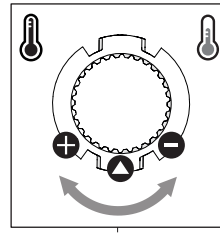

Nessuna limitazione di temperatura

No limitation of temperature

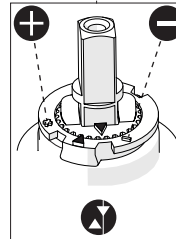

Limitazione parziale di temperatura

Partial limitation of temperature

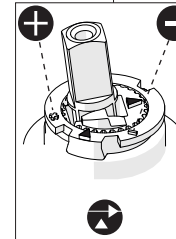

Massima limitazione Solo acqua fredda

Maximum position Only cold water



8

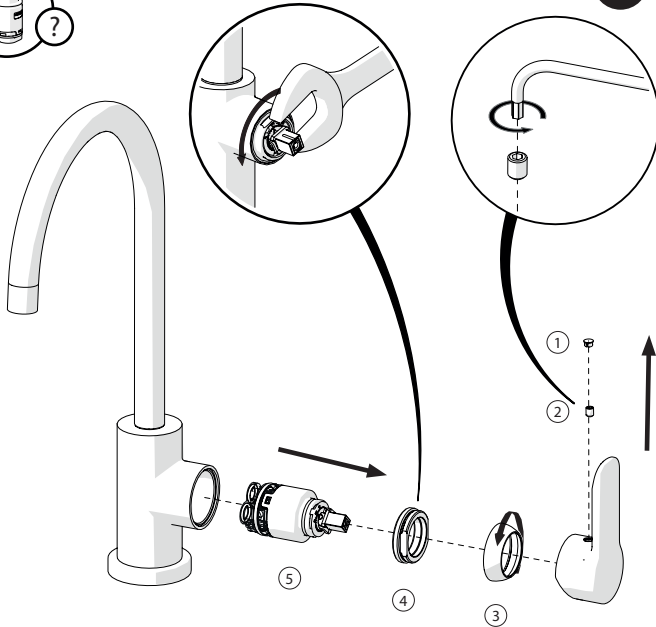

AB87133

AB87134

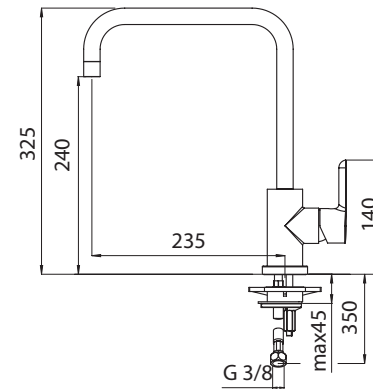
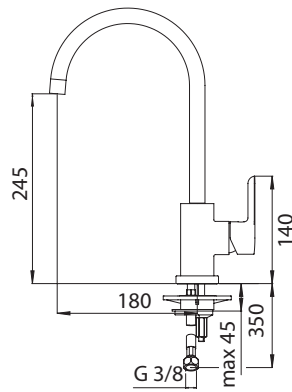

www.grupponobili.it

PRIMA DI INIZIARE / BEFORE STARTING

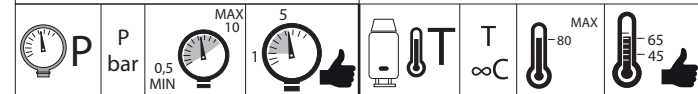

PULIZIA / CLEANING

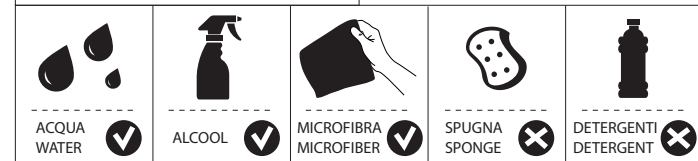

IISTRAB87133#---STD



REV1.07/2014

NOBILIS®
The Best Technology for Water

ABC

AB87133

AB87134

