

- D** Montage
- GB** Mounting
- NL** Montage
- F** Montage
- E** Montaje
- I** Montaggio
- RUS** Монтаж

KEUCO

KEUCO GmbH & Co.KG
 Postfach 1365
 D-58653 Hemer
 Telefon +49 2372 90 4-0
 Telefax +49 2372 90 42 36
 info@keuco.de
 www.keuco.de

Edition 11

Artikel-Nr.: 51185 01 1200

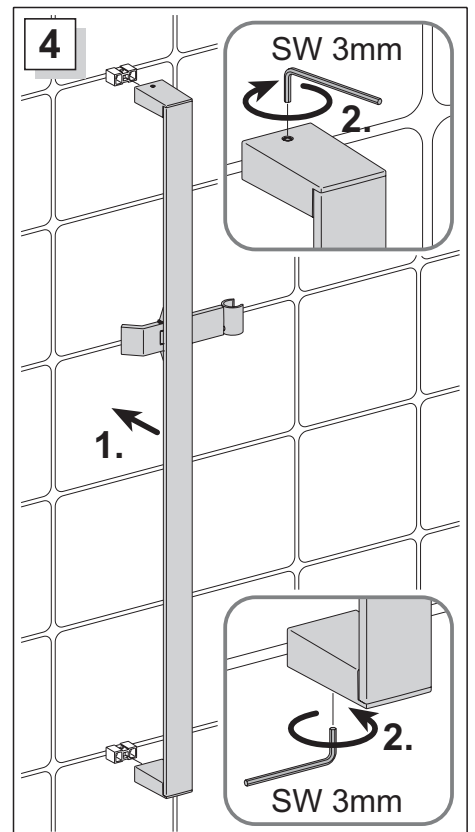
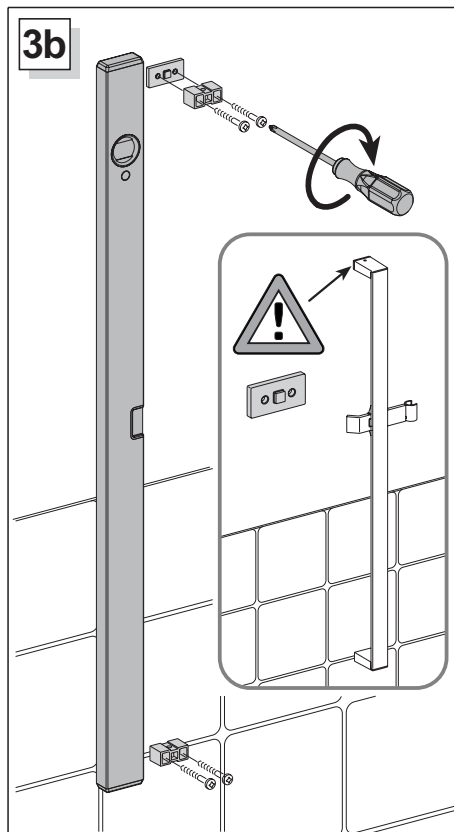
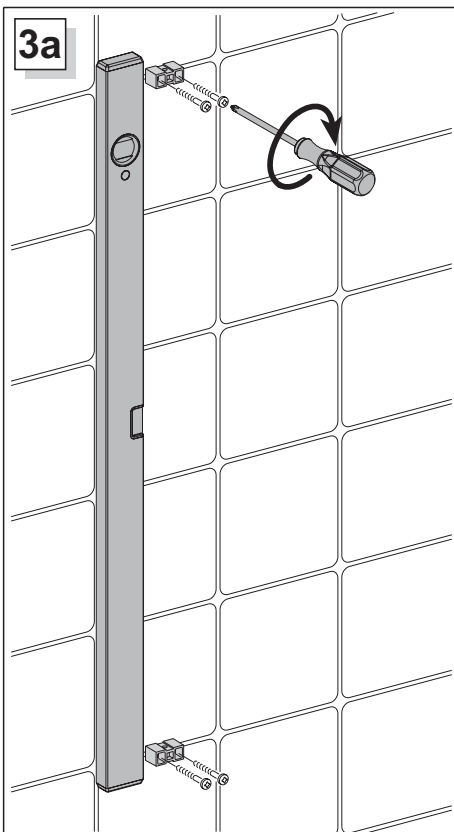
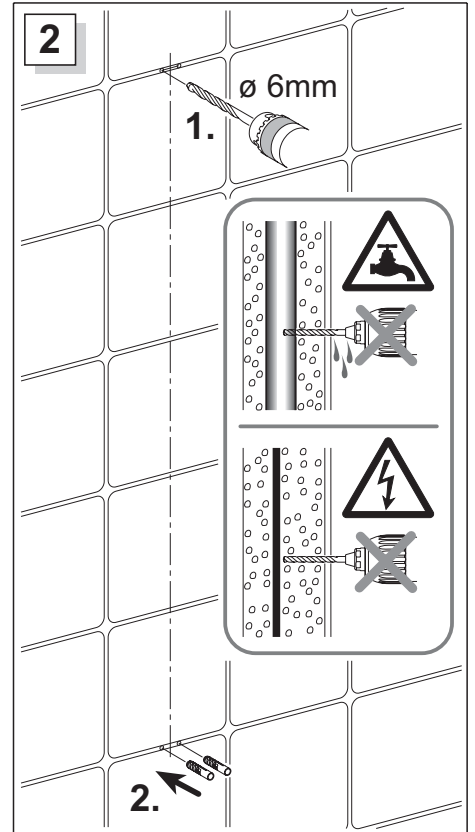
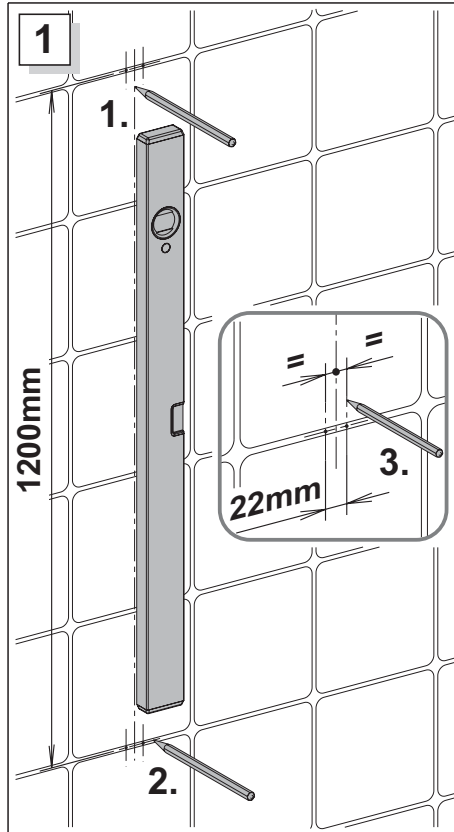
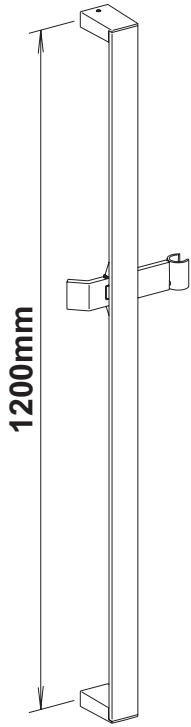

i

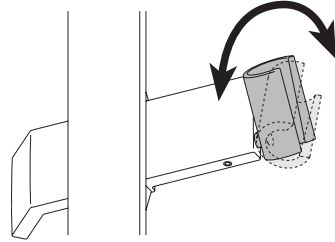
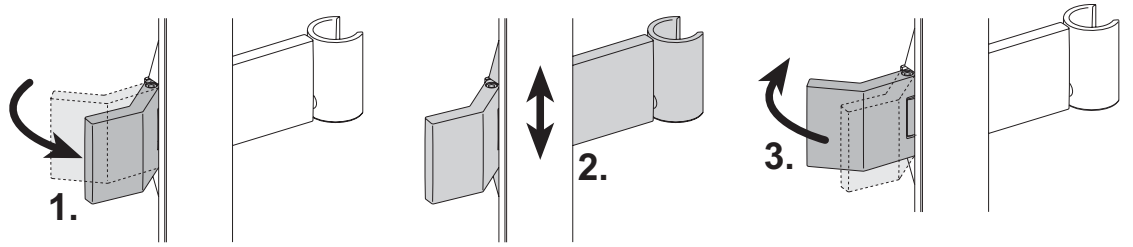
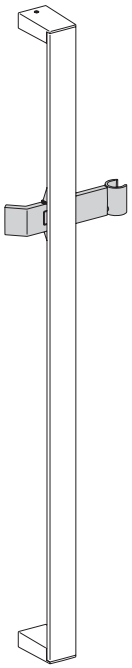

- D** Einstellung
- GB** Setting
- NL** Instelling
- F** Réglage
- E** Ajuste
- I** Regolazione
- RUS** Настройка

